

High Bright Carry-on Director Monitor

15.6"/21.5"



User Manual

Foreword

Thank you for purchasing our high bright carry-on director monitor. Please read this manual carefully before using the unit. Have a great experience!

Caution

1. Please use the adapter attached in the accessory. If necessary, please use qualified adapter.
2. Please avoid the device falling down from a high place and cause equipment damage during using.
3. The screen of this product is made of glass. Please do not drop the screen towards the ground. Keep away from injury if the screen is broken.
4. Although the device has anti-collision protection, severe collisions should also be avoided.
5. Please do NOT use chemical solutions to clean this product. Please wipe the monitor with a clean soft cloth to maintain the brightness of the surface.
6. To avoid damaging the product, please do not take apart or repair the unit by yourself without adjustable component in the unit.

Key Features

- Portable waterproof case, easily cope with various harsh shooting environments
- 1920x1080 full HD IPS screen
- Intuitive buttons + new menu interface, more convenient to operate
- Support 3D LUT Log to REC.709 and user 3D LUT upload (up

to 32)

- With Waveform, Vector scope, RGB Histogram, Focus Assist, Monochrome etc. functions, can help you accurately exposure and focus every shot.
- Stereo Earphone output, built-in speaker
- With multiple 1/4 screw thread, can be mount wireless transmission and other device.
- The bottom of case built-in metal bracket, can mount the monitor on the tripod
- Multiple power supply ways (DC IN, XLR , V-mount battery plate)

Contents

1. Production Instruction	3
1.1 Structure	3
1.2 Interface and Button Instruction	4
1.3 Power Input Way	6
2. Menu Operation Instruction	7
3. Menu Function Instruction	7
4. How to Import Custom LUT	13
5. Support Signal Formats	14
6. Parameters	15
7. Trouble Shooting	16

1. Production Instruction (take 21.5" as example)

1.1 Structure

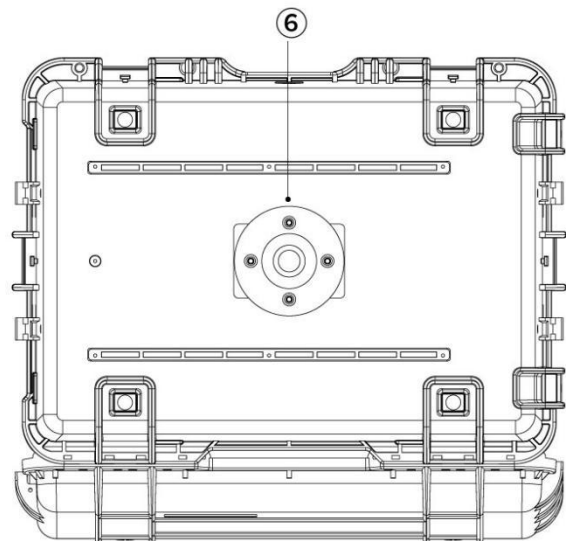
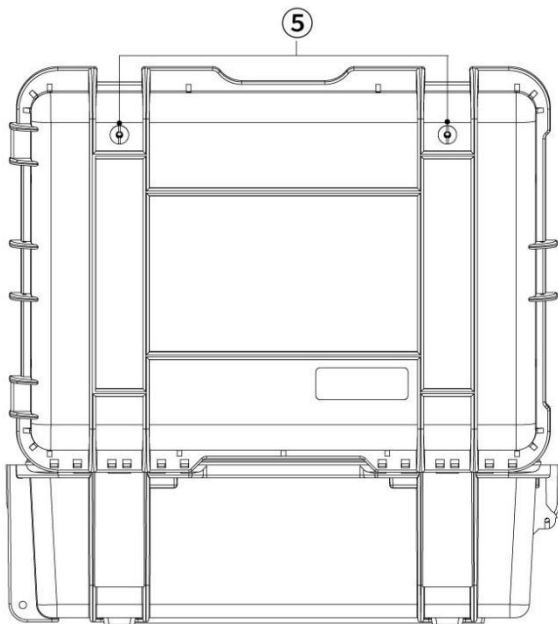
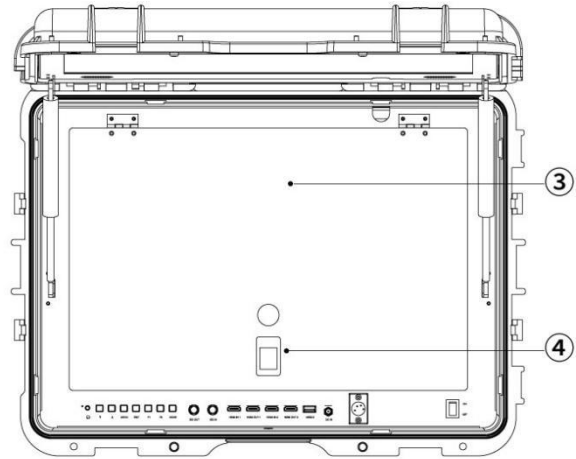
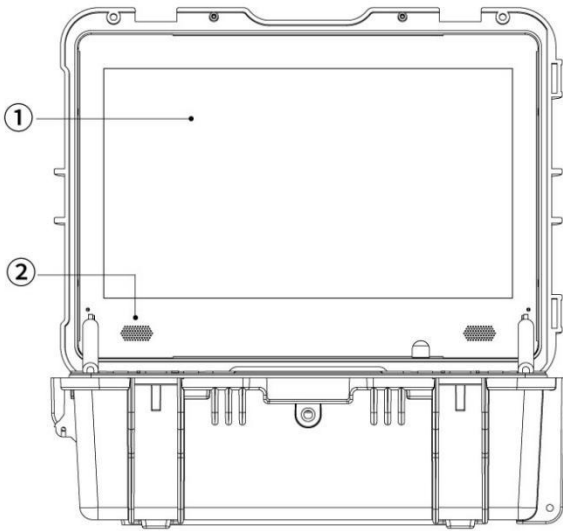

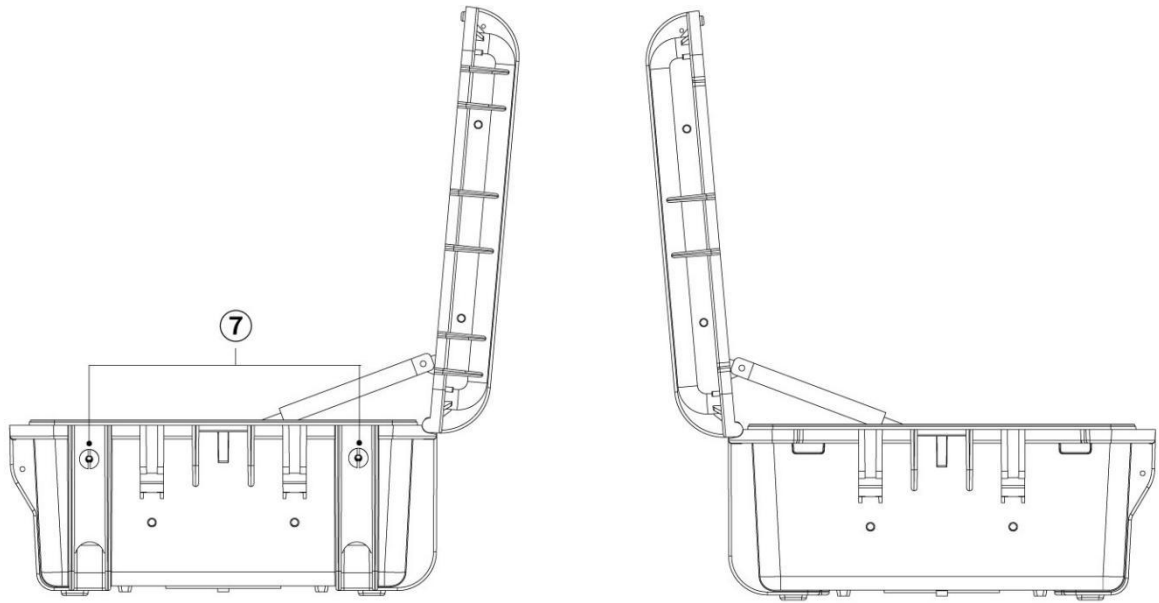

- ① : Screen
- ② : Speaker
- ③: Metal cover (You can see the battery plate after opened the cover, the left side can be put accessories or other device).
- ④: Turn on button of metal cover
- ⑤: The top of protection case with two 1/4 screw thread, can be mounted wireless transmission or other equipment.
- ⑥: The bottom of protection case built-in metal bracket, can mount the monitor on the tripod.
- ⑦: The right of protection case with two 1/4 screw thread, can be mounted wireless transmission or other equipment.

1.2 Interface and Button Instruction

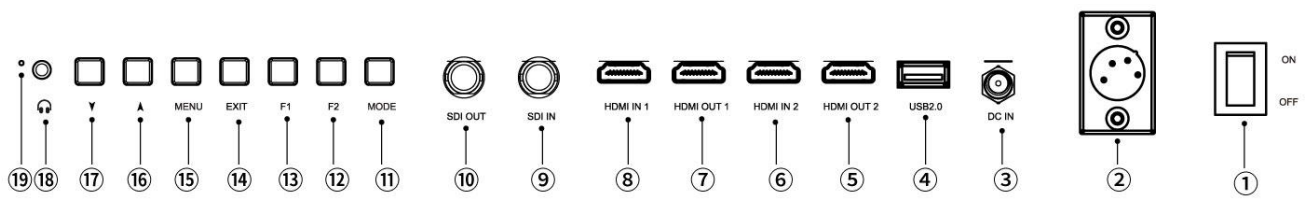

①	Power Turn ON/OFF
②	XLR power connector
③	DC power input
④	Firmware update/LUT file import interface
⑤	HDMI signal output 2
⑥	HDMI signal input 2
⑦	HDMI signal output 1
⑧	HDMI signal input 1
⑨	SDI signal input (optional)
⑩	SDI signal output (optional)
⑪	Signal switching (can be select signalHDMI1, HDMI2, SDI)
⑫	Custom shortcut key
⑬	Custom shortcut key
⑭	Return/exit menu button
⑮	Main menu/confirm button
⑯	Selecting the upper level menu/increasing the parameter value
⑰	Selecting the next level menu/decreasing the parameter value
⑱	3.5mm earphone jack
⑲	Power indicator

1.3 Power Input Way

There are three ways of power supply to our monitor:

a. Powered by the direct plug-in power input port supply.

Please select DC power plug supply and the polarity is as image below:



b. Via 4 pin XLR interface power supply, to share power with the camera or via power adapter input.

Polarity of the 4-pin XLR power input as below image, please note the polarity of the power input, otherwise it may damage monitor.

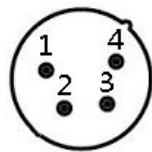

Pin number	Signal
1	GND
2	No connection
3	No connection
4	+12V

c. The monitor attached V-shape battery plate can be install battery to supply the power.



Remark: The battery is excluding. According to the different specification of the battery, the capability is different, and the working time for the monitor will be different. Higher capability (working time) will be longer.

Without the charging circuit design for the monitor, please remove the battery to charge with the battery charger.

Suggestion: Better to remove the battery if don't use this product in a long time.

2. Menu Operation Instruction

After correctly connect to the power supply, and turn on the power button, the indicator will turn yellow, and then input the signal, the indicator will turn Green from Yellow.







1. When the menu is not displayed, directly press ▼ / ▲ button to adjust volume or backlight. You can set the button to volume or backlight in the **Left Right**  **Key Set of menu User Option** 
2. Press MENU button to enter main menu, press MENU button again to enter secondary menu, and press MENU button once more to open the function menu, then press ▼ / ▲ button to select function or adjust the parameter values.
3. Press **EXIT** to exit



3. Menu Function Instruction



Assist





 <p>All Waves</p>	<p>On, Off</p> <p>After turning on, waveform, vector, histogram and embedded audio will be shown.</p>
	<p>On, Off</p> <p>Mode : RGB、 YUV、 Y</p> <p>This essential feature assists with the calibration of</p>

 <p>Waveform</p>	<p>professional video cameras. It shows the overall brightness of the image assisting the video professional in correcting exposure. The waveform feature also checks the evenness of the lighting when lighting a chromakey or background.</p> <p>Waves Trans. : Off, 25%, 50%, 75%</p>
 <p>Vector</p>	<p>On, Off</p> <p>shows how saturated the image is and where the pixels in the image land on the color spectrum.</p>
 <p>Histogram</p>	<p>On, Off</p> <p>Mode: RGB1、RGB2、Y</p> <p>RGB Histogram:It can display the graphic of color tone distribution, can intuitively display the exposure status of the image, and display overlapping histograms in red, green, and blue channels</p> <p>Y Histogram: A quantitative tool to check the picture brightness, display different color for different brightness.</p>
 <p>Focus Assist</p>	<p>On, Off</p> <p>Color : (Red, Green, Blue)</p> <p>Peaking Level : you can adjust the peaking level after turning on (1 ~ 10)</p> <p>It highlights the areas that are in focus so you are able to quickly focus the camera and not miss crucial shots.</p>
 <p>Embedded Audio</p>	<p>On, Off</p> <p>The Audio Level Meters provide numerical indicators and headroom levels.</p>
 <p>Over Exposure</p>	<p>On, Off</p> <p>Exposure Level : you can adjust the exposure level after turning on (10~100)</p> <p>Using ▼ / ▲ button to adjust the value</p>

	Areas of the image over a certain threshold are filled with a striped pattern to dramatically highlight areas where too much light is falling on the image sensor.
 Check Field	On, Off Mode : Red, Green, Blue, Gray When enabled, hue and saturation adjusted quickly and accurately
 False Colors	On, Off An image that depicts an object in colors that differ from those a photograph (a true color image) would show.









Marker

 Nine Grid	On, Off Color: Red, Green, Blue, Black, White, Gray The area of the picture can be divided into 9 equal grids.
 Safe Frames	On, Off Mode: 80%, 85%, 90%, 93%, 96%, 2.35:1 Color: Red, Green, Blue, Black, White, Gray
 Center Marker	On, Off Color : Red, Green, Blue, Black, White, Gray
 Ratio Marker	On, Off Mode: 4:3、 13:9、 14:9、 15:9、 16:9、 1.85:1、 2.35:1 Color: Red, Green, Blue, Black, White, Gray Modified Mark : 0~5









Image

 Scan Mode	Under Scan, Over Scan
 Aspect Ratio	Auto, 16:9, 16:10, 4:3, 5:4, 1.85:1, 2.35:1, Full Screen Provides a wide variety of aspect ratio to match different camera anamorphic lenses.
 Anamorphic	On, Off Mode: 1.33X, 1.6X, 2.0X, 2.0X MAG, User Under the User , can be customized (1.20X~2.00X) Allows you to use anamorphic lenses or adapters and see the image unsqueezed, even if your camera does not de-squeeze in camera.
 Image Flip	On, Off Mode: H Flip, V Flip, H_V Flip
 Zoom Mode	On, Off Mode: 2X、4X、9X、16X、User Under the User , can be customized (100%~200%) It is HD signal in any part, an amplification for high quality close-up
 Image Freeze	On, Off
 P2P	On, Off Enable the filmmaker to check the image from the 1:1 signal source without scaling. This feature is essential for capturing optimum detail.



User Option





 <p>LUT</p>	<p>On, Off</p> <p>After the LUT Switch is turned on, you can use the Lut (SLOG2, SLOG3, LOGC, VLOG).</p> <p>The Lut item is displayed after the Lut Switch is turned on.</p> <p>LUT is a table for quickly looking up and output specific color data. By loading different 3D-LUT tables, it can quickly recombine color tone to form different color styles</p> <p>Lut Import: Confirm</p> <p>After copying the 3D LUT file to the USB flash drive, then inserting it the USB2.0 port, press MENU button Confirm to import the 3D LUT file.</p> <p>Lut Table</p> <p>Show the 4 built-in Lut and the custom load Lut (up to 32)</p>
 <p>Display Adjustment</p>	<p>Backlight: 0~100</p> <p>Adjust the screen brightness</p> <p>Brightness: 0~100</p> <p>Adjust the image brightness</p> <p>Contrast: 0~100</p> <p>Adjustment of the ratio between the brightest and darkest parts of the image . When adjusting, pay attention to the sense of hierarchy in the image. If the proportion is too large or too small, it can cause the image to lose its colorful appearance.</p>

	<p>Saturation: 0~100</p> <p>Adjustment of color concentration</p> <p>Tint: 0~100</p>
 <p>Color Adjustment</p>	<p>Color Temp.: 5600K, 6500K, 9300K, User</p> <p>Under the User, the red, green and blue of the image can be adjusted (0~255)</p>
 <p>Shortcut Key</p>	<p>All Waves, Waveform, Vector, Histogram, Embedded Audio, Center Marker, Safe Frames, Nine Grid, Focus Assist, False Colors, Over Exposure, Anamorphic, Image Freeze, Check Field, Zoom Mode, Image Flip, Aspect Ratio</p> <p>To set the 2 shortcut custom button F1, F2 on the panel e.g.: After entering the main menu, use the ▼ / ▲ button to select the shortcut key  in the User Option and press the MENU button to confirm, then select F1 and press MENU button to confirm to call out the custom function menu bar, use the / key to select one of the functions and press MENU to confirm, the cursor will be changed to gray color after confirmed.</p> <p>Same setting for F2</p>
 <p>Left Right Key Set</p>	<p>Volume, Backlight</p>



System

	<p>English、简体中文、Español、Português、Français、Nederlands、Deutsch、日本語、繁體中文、한국어로、</p>
---	--

<p>Language</p>	<p>русский язык</p>
<p> OSD Option</p>	<p>OSD Time: Off, 15Sec, 30Sec, 45Sec Select the display time of the menu on the screen</p> <p>OSD Trans: Off, 25%, 50%, 75% Adjust the transparency of the menu picture background on the screen</p> <p>No Signal: Red, Green, Blue, Black, White, Gray Can be change the background color of screen when no signal</p>
<p> Volume</p>	<p>On, Off 0~100 Adjusting the speaker volume</p>
<p> Reset</p>	<p>Scroll the wheel to select Reset and press Confirm, the system back to original setting.</p>
<p> Firmware Update</p>	<p>Firmware Version V1.0.6 FTY CAL: ON/OFF @Cal_Lut</p> <p>Each monitor has color calibration before ex-factory, the factory calibration button turn on by default. After turning off, the monitor will without has color calibration, suggest don't turn it off.</p> <p>After copying the upgrade file to the USB flash drive and inserting the USB2.0 port, press "MENU" button Confirm to update. After the upgrade, monitor will automatically restart.</p>

4. How to Import Custom LUT

4.1 USB flash driver format

Supports FAT32

4.2 Max Files Limit Maximum 36 Lut files

4.3 File requirements

- The LUT file format suffix should be **.cube**
- Single file not exceeded to 7.9Mb
- Support LUT-3D-Size **16,17,32,33,64,65**

Remark: LUT file name must be English or Arabic numerals

4.4 Steps for loading

4.4.1 Make sure the USB flash driver correctly insert

4.4.2 Enter main menu **User Option--LUT-- Import -- Confirm** to load

the monitor will auto detect the USB flash driver

If there is valid lut file in USB flash driver, the monitor will load LUT files and show “[n] name. The [n] shows the quantity number. The “name” should in LUT files’ name. If load successful, the screen will show “complete[n]”. [n] Stands for the quantity number for LUT files should under 36.

PS: How to clear up the imported LUTs?

Insert a empty USB flash driver to the monitor, enter main menu **User Option--LUT-- Import -- Confirm**, the imported LUTs will be clear up.

5. Support Signal Formats

HDMI Support Format	480i /480p /576i /576p 720p(60/59.94/50/30/29/25/24/23.98) 1080i(60/59.94/50) 1080p(60/59.94/50/30/29.97/25/24/24sF/23.98/23.98sF) 4K UHD 3840×2160p (30/29.97/25/24/23.98 Hz) 4096×2160p (24Hz)
----------------------------	---

SDI Support Format	720p (60/59.94/50/30/29/25/24/23.98) 1080i (60/59.94/50) 1080p(60/59.94/50/30/29.97/25/24/24sF/23.98/23.98sF)
---------------------------	---

6. Parameters

Panel Size	15.6"	21.5"
Resolution	1920x1080	1920x1080
Dot Pitch	0.179125 (H) x 0.17925	0.24795 (H) x 0.24795 (V)
Aspect Ratio	16:9	16:9
Brightness	1000cd/m ²	1000cd/m ²
Contrast	800:1	1000:1
Viewing Angle	85°/85°(L/R) 85°/85°(U/D)	89°/89°(L/R) 89°/89°(U/D)
Backlight	LED	
Input	2*HDMI, 1*SDI (optional), 1*USB2.0	
Output	2*HDMI, 1*SDI (optional)	
Audio	3.5mm Stereo Headphone, Speakers	
Input Voltage	DC: 12~24V	
Power Consumption	≦ 25W	≦ 38W
Unit Size	479x387x210 (mm)	596x440x240 (mm)
Unit Weight	About 9.8kg	About 14.8kg
Install Way	1/4-20 mount points (top, right)	
Waterproof Level of Case	IP67	
Material of Case	PP Alloy	
Working Temperature	-0°C ~ 50°C	

Storage Temperature	-20℃～60℃
----------------------------	----------

7. Trouble Shooting

If there is any problem when using the unit, please try following ways to inspect and solve. Please contact us if you still cannot solve it or have other problems.

● Without image display	Trouble shooting
◆ Video cable off or connect incorrectly	Check the quality of the cable, make sure the correct input interface
◆ Without video signal input	Check the signal source and output interface connect is corrected or not
◆ Monitor cannot be powered on	Check whether the power is connected, put the power switch to “on” position
◆ Supply voltage instability	The power adapter or battery is poor connected with battery plate
◆ self-contained power supply, polarity connect inversely	Reference "Power input way" reconnect

● Image/color display abnormal	Trouble shooting
◆ Video cable poor contact	Change video cable, try again
◆ Video signal interfered by external environment	Move to another environment to try again
◆ Video input signal amplitude too low	Check signal source video output, or change signal source and have a try.
◆ Menu color saturation adjustment closing	Enter menu to check color, or reset to factory settings
◆ Check Field set in mono or black & white	Reset Check Field, back to the color

◆ Image deformation	Reset the image ratio
---------------------	-----------------------

● Speaker without sound	Trouble shooting
◆ Audio cable off or improper connection	Confirm connected with the corresponding input port
◆ Volume adjustment was closed	Reset the volume control and adjust to a proper position
◆ HDMI or SDI cable poor Connected	Check the quality of cable, or change cable and have a try

■ **Remark:**

★ If there are still other problems, please contact with our related technical persons.

★ If there are changes without prior notice.